

TIP125/TIP126/TIP127

PNP Epitaxial Darlington Transistor

- Medium Power Linear Switching Applications
- Complementary to TIP120/121/122

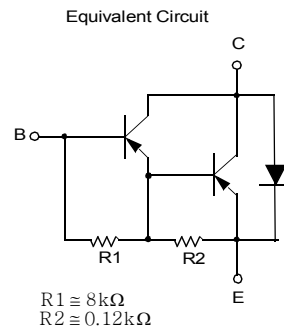
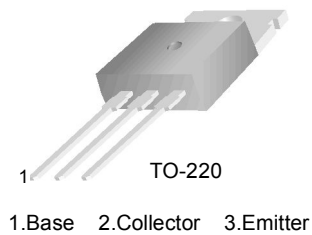

Absolute Maximum Ratings* $T_a = 25^\circ\text{C}$ unless otherwise noted

Symbol	Parameter	Ratings	Units
V_{CBO}	Collector-Base Voltage : TIP125	- 60	V
	: TIP126	- 80	V
	: TIP127	- 100	V
V_{CEO}	Collector-Emitter Voltage : TIP125	- 60	V
	: TIP126	- 80	V
	: TIP127	- 100	V
V_{EBO}	Emitter-Base Voltage	- 5	V
I_C	Collector Current (DC)	- 5	A
I_{CP}	Collector Current (Pulse)	- 8	A
I_B	Base Current (DC)	- 120	mA
P_C	Collector Dissipation ($T_a=25^\circ\text{C}$)	2	W
	Collector Dissipation ($T_C=25^\circ\text{C}$)	65	W
T_J	Junction Temperature	150	$^\circ\text{C}$
T_{STG}	Storage Temperature	- 65 ~ 150	$^\circ\text{C}$

* These ratings are limiting values above which the serviceability of any semiconductor device may be impaired.

Electrical Characteristics* $T_a=25^\circ\text{C}$ unless otherwise noted

Symbol	Parameter	Test Condition	Min.	Typ.	Max.	Units
$V_{\text{CEO(sus)}}$	Collector-Emitter Sustaining Voltage : TIP125 : TIP126 : TIP127	$I_C = -100\text{mA}, I_B = 0$	-60 -80 -120			V V V
I_{CEO}	Collector Cut-off Current : TIP125 : TIP126 : TIP127	$V_{\text{CE}} = -30\text{V}, I_B = 0$ $V_{\text{CE}} = -40\text{V}, I_B = 0$ $V_{\text{CE}} = -50\text{V}, I_B = 0$			-2 -2 -2	mA mA mA
I_{CBO}	Collector Cut-off Current : TIP125 : TIP126 : TIP127	$V_{\text{CB}} = -60\text{V}, I_E = 0$ $V_{\text{CB}} = -80\text{V}, I_E = 0$ $V_{\text{CB}} = -100\text{V}, I_E = 0$			-1 -1 -1	mA mA mA
I_{EBO}	Emitter Cut-off Current	$V_{\text{BE}} = -5\text{V}, I_C = 0$			-2	mA
h_{FE}	* DC Current Gain	$V_{\text{CE}} = -3\text{V}, I_C = 0.5\text{A}$ $V_{\text{CE}} = -3\text{V}, I_C = -3\text{A}$	1000 1000			
$V_{\text{CE(sat)}}$	* Collector-Emitter Saturation Voltage	$I_C = -3\text{A}, I_B = -12\text{mA}$ $I_C = -5\text{A}, I_B = -20\text{mA}$			-2 -4	V V
$V_{\text{BE(on)}}$	* Base-Emitter On Voltage	$V_{\text{CE}} = -3\text{V}, I_C = -3\text{A}$			-2.5	V
C_{ob}	Output Capacitance	$V_{\text{CB}} = -10\text{V}, I_E = 0, f = 0.1\text{MHz}$			300	pF

* Pulse Test: Pulse Width $\leq 300\mu\text{s}$, Duty Cycle $\leq 2\%$

Typical Characteristics

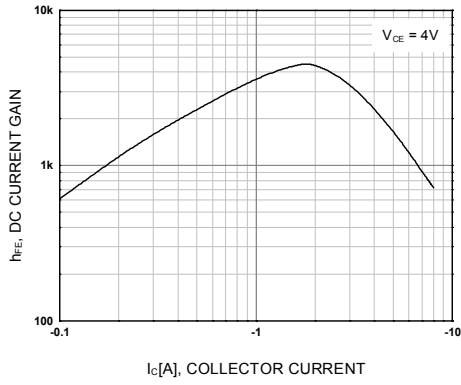

Figure 1. DC current Gain

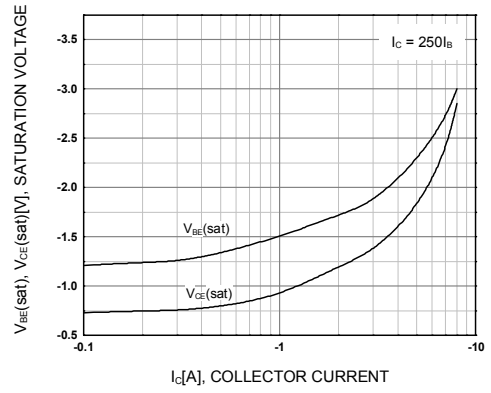

Figure 2. Base-Emitter Saturation Voltage
Collector-Emitter Saturation Voltage

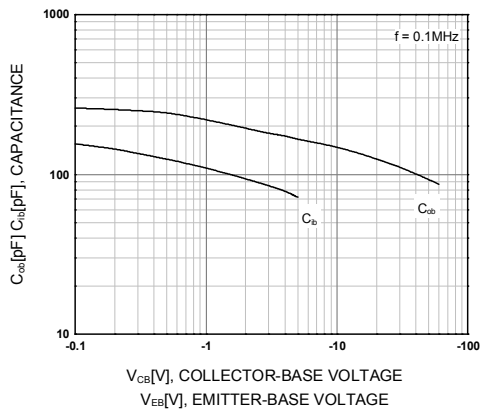

Figure 3. Output and Input Capacitance
vs. Reverse Voltage

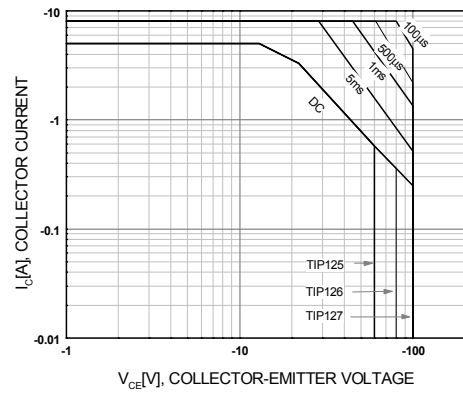

Figure 4. Safe Operating Area

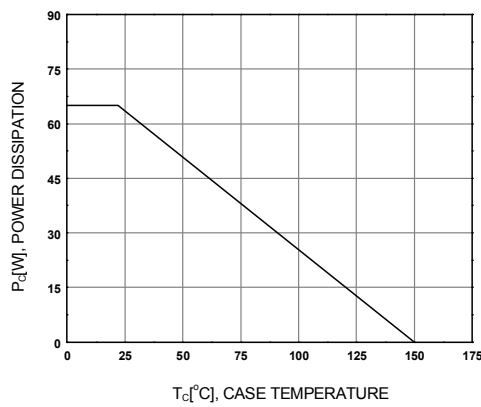
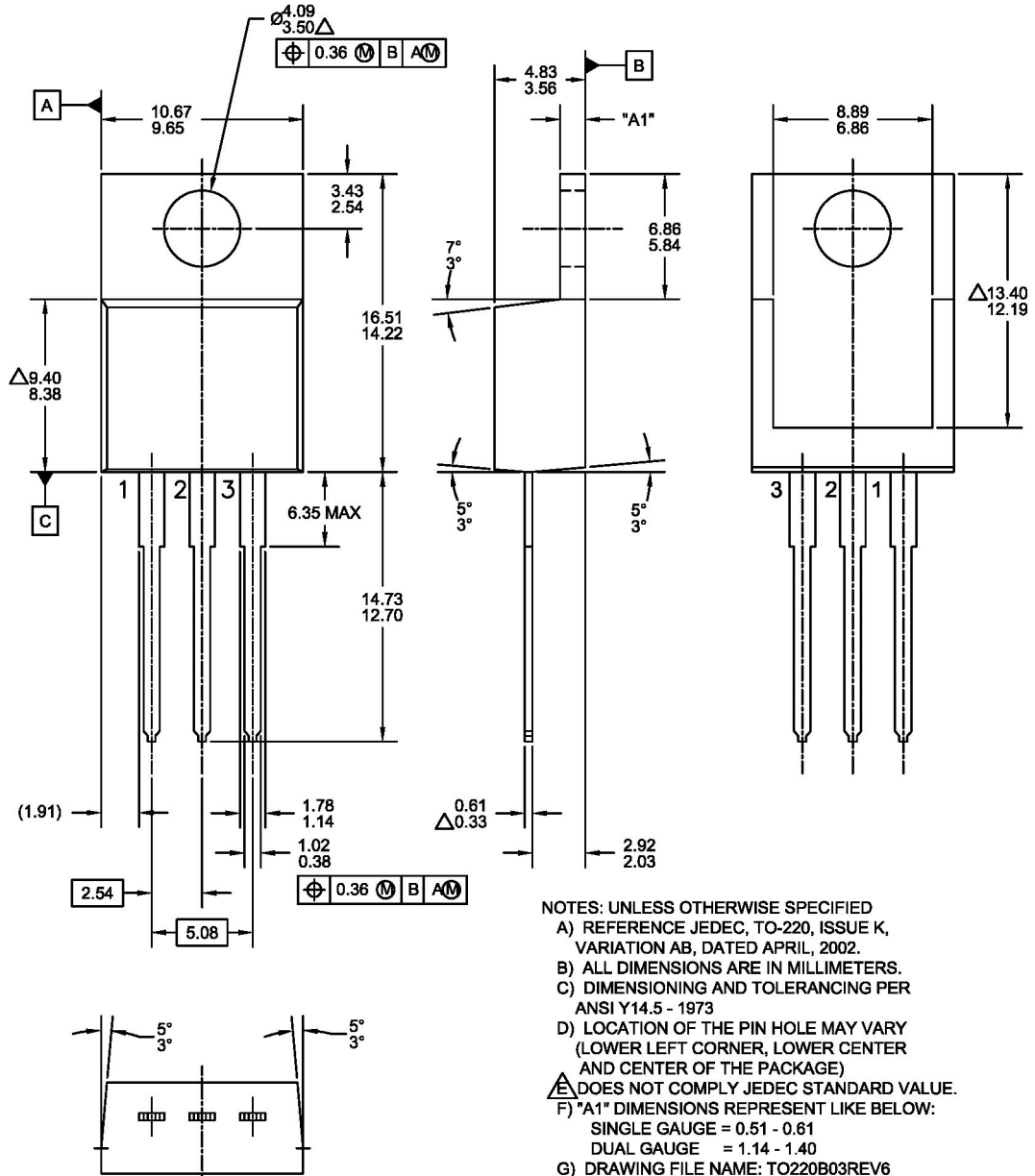

Figure 5. Power Derating

Mechanical Dimensions

TO220



- NOTES: UNLESS OTHERWISE SPECIFIED
- REFERENCE JEDEC, TO-220, ISSUE K, VARIATION AB, DATED APRIL, 2002.
 - ALL DIMENSIONS ARE IN MILLIMETERS.
 - DIMENSIONING AND TOLERANCING PER ANSI Y14.5 - 1973
 - LOCATION OF THE PIN HOLE MAY VARY (LOWER LEFT CORNER, LOWER CENTER AND CENTER OF THE PACKAGE)
 - Δ DOES NOT COMPLY JEDEC STANDARD VALUE.
 - "A1" DIMENSIONS REPRESENT LIKE BELOW:
SINGLE GAUGE = 0.51 - 0.61
DUAL GAUGE = 1.14 - 1.40
 - DRAWING FILE NAME: TO220B03REV6