

**MUR170E-MUR1100E**
**1A SCHOTTKY RECTIFIER**
**MAXIMUM RATINGS**

Rating	Symbol	MUR				Unit
		170E	180E	190E	1100E	
Peak repetitive reverse voltage Working peak reverse voltage DC blocking voltage	$V_{RRM}$ $V_{RWM}$ $V_R$	700	800	900	1000	V
Average rectified forward current (square wave) Mounting method per note 2	$I_{F(AV)}$	1.0 @ $T_A = 95^\circ\text{C}$				A
Non-repetitive peak surge current (surge applied at rated load conditions halfwave, single phase, 60Hz)	$I_{FSM}$	35				A
Operating and storage junction temperature range	$T_J, T_{stg}$	-65 to +175				$^\circ\text{C}$
Maximum thermal resistance Junction to ambient	$R_{\theta JA}$	Note 1				$^\circ\text{C/W}$

**ELECTRICAL CHARACTERISTICS ( $T_C = 25^\circ\text{C}$  unless otherwise noted)**

Parameter	Symbol	MUR				Unit
		170E	180E	190E	1100E	
Maximum instantaneous forward voltage <sup>(1)</sup> ( $I_F = 1.0\text{A}, T_J = 150^\circ\text{C}$ ) ( $I_F = 1.0\text{A}, T_J = 25^\circ\text{C}$ )	$V_F$	1.50 1.75				V
Maximum instantaneous reverse current <sup>(1)</sup> (Rated dc voltage, $T_J = 100^\circ\text{C}$ ) (Rated dc voltage, $T_J = 25^\circ\text{C}$ )	$I_R$	600 10				$\mu\text{A}$
Maximum reverse recovery time ( $I_F = 1.0\text{A}, di/dt = 50\text{A}/\mu\text{s}$ ) ( $I_F = 0.5\text{A}, I_R = 1.0\text{A}, I_{REC} = 0.25\text{A}$ )	$t_{rr}$	100 75				ns
Maximum forward recovery time ( $I_F = 1.0\text{A}, di/dt = 100\text{A}/\mu\text{s}, I_{REC}$ to 1.0V)	$t_{fr}$	75				ns
Controlled avalanche energy	$W_{AVAL}$	10				mJ

Note 1: Pulse test: Pulse width = 300 $\mu\text{s}$ , duty cycle  $\leq 2.0\%$ .  
Note 2: PC board with 1 1/2" x 1 1/2" copper surface.

**MECHANICAL CHARACTERISTICS**

Case	DO-41
Marking	Body painted, alpha-numeric
Polarity	Cathode band

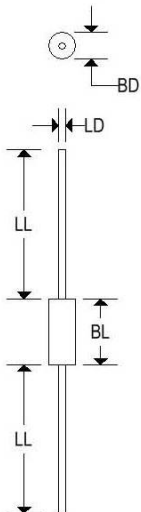

	DO-41			
	Inches		Millimeters	
	Min	Max	Min	Max
BD	-	0.107	-	2.720
BL	-	0.205	-	5.207
LD	0.028	0.034	0.711	0.864
LL	1.000	-	25.400	-

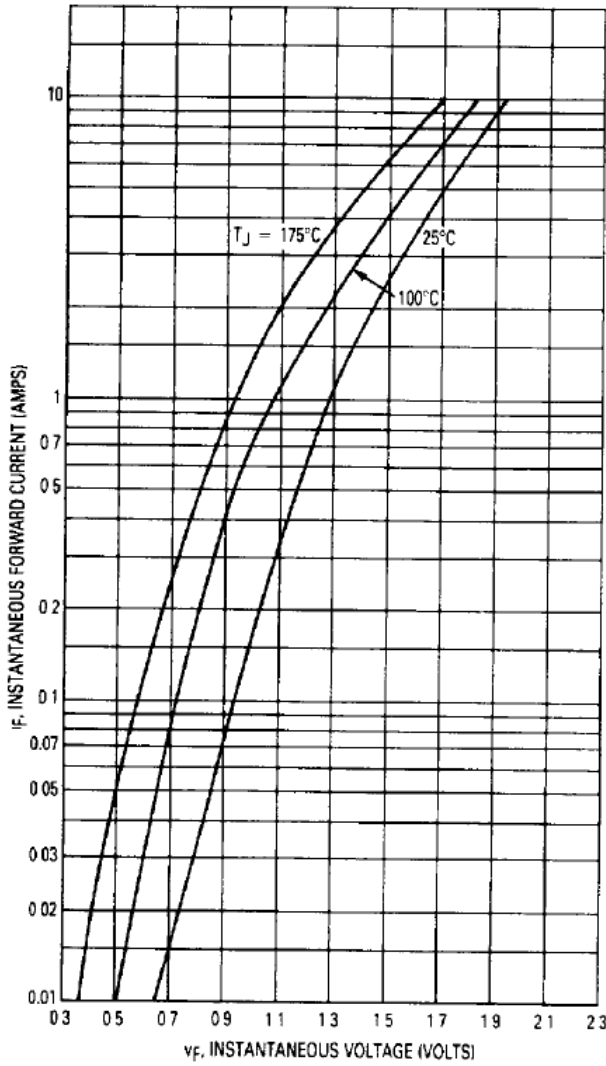

Figure 1. Typical Forward Voltage

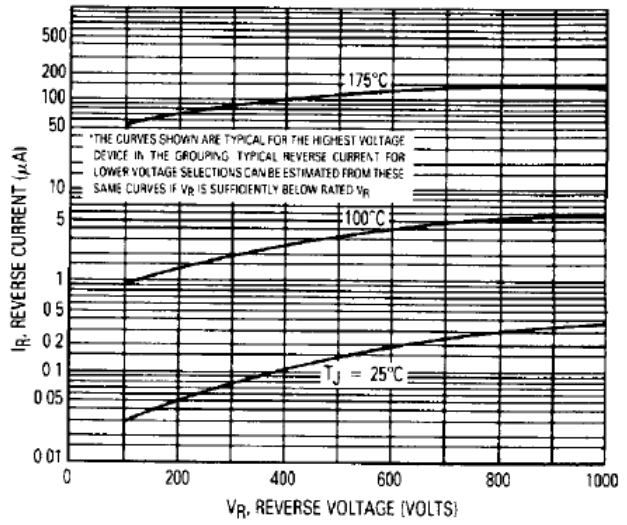

Figure 2. Typical Reverse Current\*

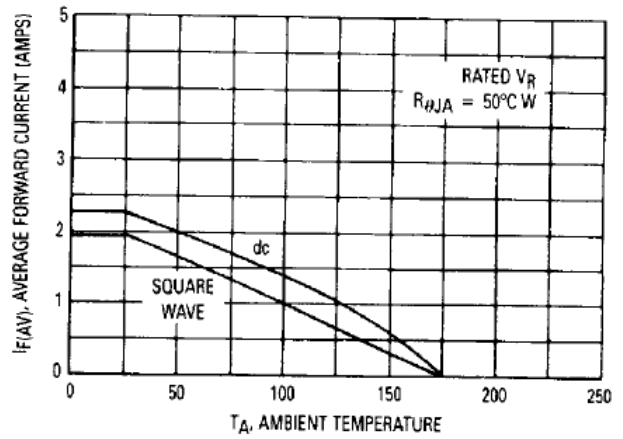

Figure 3. Current Derating (Mounting Method #3 Per Note 1)

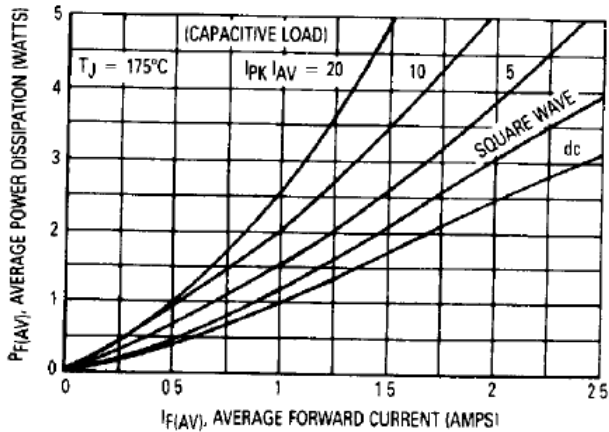

Figure 4. Power Dissipation

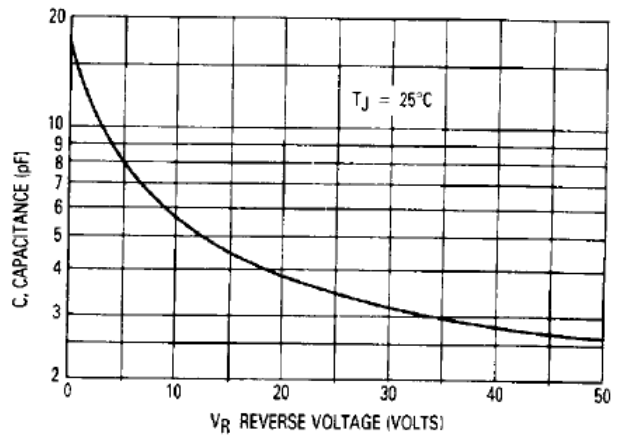

Figure 5. Typical Capacitance

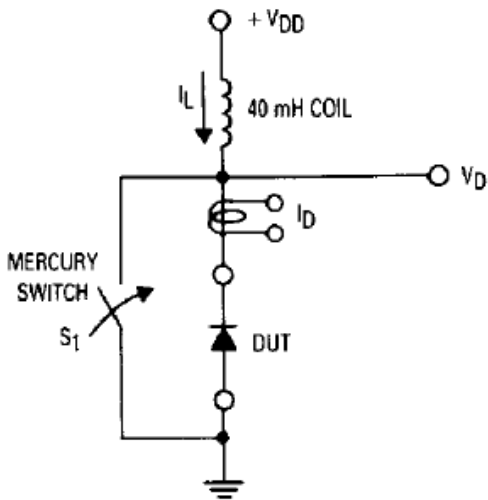

Figure 6. Test Circuit

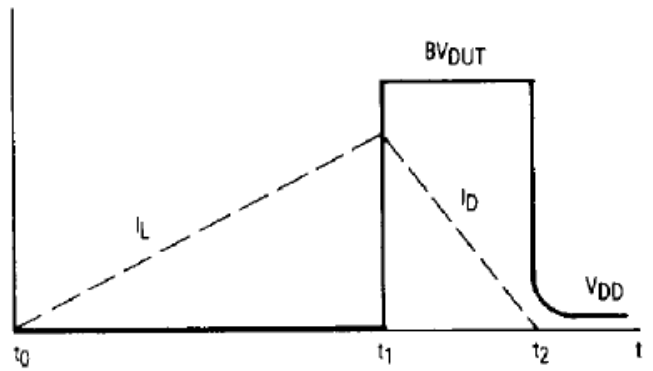

Figure 7. Current-Voltage Waveforms

Available Non-RoHS (standard) or RoHS compliant (add PBF suffix).  
Available as "HR" (high reliability) screened per MIL-PRF-19500, JANTX level. Add "HR" suffix to base part number.