

CODIGO	DESCRIPCION
CR0805-XXX	Resistor SMD 0805

## THICK FILM CHIP RESISTORS RC SERIES

### FEATURES

- Extremely thin and light
- Highly reliable multilayer electrode construction
- Compatible with all soldering process
- Highly stable I auto—placement surface mounting applications
- Barrier layer end termination
- Zero Ohm jumper available
  - Available in 8mm Tape and Reel per EIA RS481
- RoHS compliant

### CONSTRUCTION

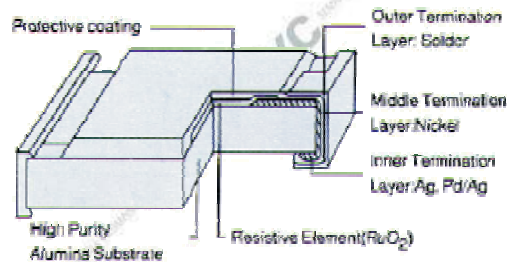
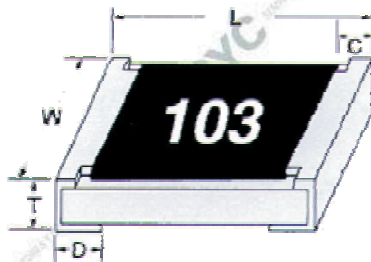





Ordering code :

**RC 0805 F R = 100R**

<b>Size</b> 0201 0402 0603 0805 1206 1210 2012 2512	<b>Tolerance</b> F=±1% J=±5% On request G=±2%	<b>Packing style</b> R = Paper K = Embossed Plastic	<b>Special Type</b> - = 7 inch Dia. Reel (Standard) 10 = 10 inch Reel (non preferred) 13 = 13 inch Reel	<b>Resistance Value</b> for example 1R 10 KR 10R 100KR 100R 1MR 1KR 10MR
---	---	--	--	---

### Marking Diagrams

				
NO MARKING	Value=10 KΩ	Value=10 KΩ	Value=12.4 KΩ	E-24 1% Value=56 K
RC0201	5% marking	1% marking	1% marking for	1% marking for RC0603
RC0402	RC0603 RC0805	RC0805 RC1206	RC0603	EIA-24 series items
	RC1206 RC1210	RC1210 RC2010	EIA-96 series items	
	RC2010 RC2512	RC2512		

### Marking explanation

- 5% tolerance: 3 digits, first two digits are significant figures, third digit is number of zeros.
- 1% tolerance: 4 digits. First three digits are significant figures, fourth digit is number of zeros.
- Letter R is decimal point.
- RC0603 1%: EIA-96 marking at following page, when values in E-24 series marking as last column of above

**CODIGO**

CR0805-XXX

**DESCRIPCION**

Resistor SMD 0805

**GENERAL SPECIFICATION**

**■ DIMENSION (mm)**

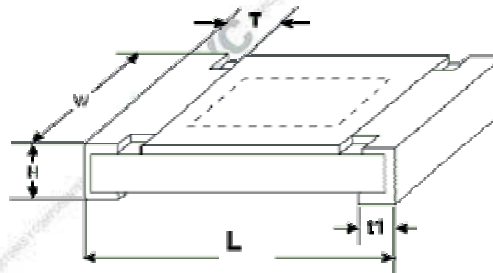

EIA Size	Power Rating (at 70°C)	L	W	H	T	t1
0201	1/20W	0.6±0.10	0.3±0.05	0.25±0.05	0.15±0.10	0.15±0.10
0402	1/16W	1.0±0.10	0.5±0.05	0.30±0.05	0.20±0.10	0.25±0.10
0603	1/10W	1.6±0.10	0.8±0.10	0.45±0.10	0.25±0.15	0.25±0.15
0805	1/8W	2.0±0.10	1.20±0.10	0.55±0.10	0.35±0.20	0.35±0.20
1206	1/4W	3.1±0.15	1.55±0.15	0.55±0.10	0.45±0.20	0.40±0.20
1210	1/2W	3.1±0.15	2.60±0.15	0.55±0.10	0.50±0.20	0.50±0.20
2010	3/4W	5.0±0.15	2.50±0.15	0.55±0.10	0.60±0.20	0.50±0.20
2512	1W	6.4±0.15	3.20±0.15	0.55±0.10	0.60±0.20	0.50±0.20

**■ RATING**

SIZE	Power Rating at 70°C	Max W.V.	Max Over Load Volt	Resistance Tol. (%)	Resistance Range (Ω)	TCR ppm/°C	Normal Res. Value	
RC0201	1/20W	15V	50V	±5 ±1	0 ohm Jumper 1Ω~1MΩ	10~10MΩ: 250 R ≤ 10Ω : -100/+600	E-24 for 5% E-96 for 1%	
RC0402	1/16W	50V	100V	±5 ±1	0 ohm Jumper 1Ω~10MΩ	100 ppm/°C for range 10~10MΩ  200 ppm/°C for range R ≤ 10Ω R > 10MΩ	E-24 for 5% E-96 for 1%	
RC0603	1/10W	50V	100V	±5 ±1	0R, 1Ω~22MΩ 1Ω~10MΩ		E-24 for 5% E-96 for 1%	
RC0805	1/8W	150V	300V	±5 ±1	0R, 1Ω~22MΩ 1Ω~10MΩ		E-24 for 5% E-96 for 1%	
RC1206	1/4W	200V	400V	±5 ±1	0R, 1Ω~22MΩ 1Ω~10MΩ		E-24 for 5% E-96 for 1%	
RC1210	1/2W	200V	500V	±5 ±1	0R, 1Ω~22MΩ 1Ω~10MΩ		E-24 for 5% E-96 for 1%	
RC2010	3/4W	200V	500V	±5 ±1	0R, 1Ω~22MΩ 1Ω~10MΩ		E-24 for 5% E-96 for 1%	
RC2512	1W	200V	500V	±5 ±1	0R, 1Ω~22MΩ 1Ω~10MΩ			E-24 for 5% E-96 for 1%
								E-24 for 5% E-96 for 1%

Operating Temp. Range : -55 ~ +155°C

**CODIGO**

CR0805-XXX

**DESCRIPCION**

Resistor SMD 0805

**DERATING CURVE**

For resistors operated in ambient temperatures above 70 °C, power rating just be derated in accordance with curve below.

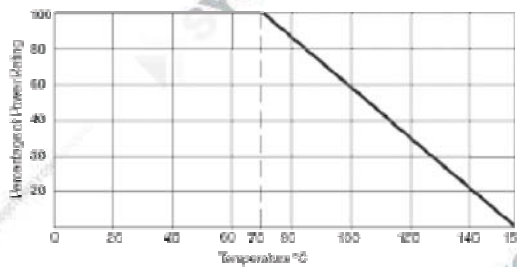

**0603 1% Marking Table**

Code	E48	E96	Code	E48	E96	Code	E48	E96	Code	E48	E96
01	100	100	25	178	178	49	316	316	73	562	562
02		102	26		182	50		324	74		576
03	105	105	27	187	187	51	332	332	75	590	590
04		107	28		191	52		340	76		604
05	110	110	29	196	196	53	348	348	77	619	619
06		113	30		200	54		357	78		634
07	115	115	31	205	205	55	365	365	79	649	649
08		118	32		210	56		374	80		665
09	121	121	33	215	215	57	383	383	81	681	681
10		124	34		221	58		392	82		698
11	127	127	35	226	226	59	402	402	83	715	715
12		130	36		232	60		412	84		732
13	133	133	37	237	237	61	422	422	85	750	750
14		137	38		243	62		432	86		768
15	140	140	39	249	249	63	442	442	87	787	787
16		143	40		255	64		453	88		806
17	147	147	41	261	261	65	464	464	89	825	825
18		150	42		267	66		475	90		845
19	154	154	43	274	274	67	487	487	91	866	866
20		158	44		280	68		499	92		887
21	162	162	45	287	287	69	511	511	93	909	909
22		165	46		294	70		523	94		931
23	169	169	47	301	301	71	536	536	95	953	953
24		174	48		309	72		549	96		976

This table shows the first two digits for the 3 digits EIA-96 part marking scheme.

The 3<sup>rd</sup> character is a letter multiplier : Y=10<sup>-2</sup>, X=10<sup>-1</sup>, A=10<sup>0</sup>, B=10<sup>1</sup>, C=10<sup>2</sup>, D=10<sup>3</sup>, E=10<sup>4</sup>, F=10<sup>5</sup>

**CODIGO**

CR0805-XXX

**DESCRIPCION**

Resistor SMD 0805

**SPECIFICATION AND TEST METHOD**

Characteristics	Specification	Test Method
Short time overload	5% $\Delta R(2\% + 0.05 \Omega)$ Max. 1% $\Delta R(1\% + 0.05 \Omega)$ Max.	JIS C5202 5.5 / IEC 60115-1 4.13 Rated voltage $\times$ 2.5 times for 5 seconds at room temperature
Insulation resistance	Between termination and coating must be over 10 G $\Omega$	JIS C5202 5.6 / IEC 60115-1 4.6.1.1 Test voltage : 100V
Bending strength	5% $\Delta R(1\% + 0.05 \Omega)$ Max. 1% $\Delta R(1\% + 0.05 \Omega)$ Max. No mechanical damage	IEC 60115-1 4.15 Bending 5mm on the 90mm PCB
Temperature cycling	5% $\Delta R(2\% + 0.05 \Omega)$ Max. 1% $\Delta R(1\% + 0.05 \Omega)$ Max. No mechanical damage	JIS C5202 7.4 / IEC60115-1 4.19 -55 $^{\circ}$ C ( 30 min ) to +125 $^{\circ}$ C ( 30 min ) 5 cycles
Load life in moisture	5% $\Delta R(2\% + 0.05 \Omega)$ Max. 1% $\Delta R(0.5\% + 0.05 \Omega)$ Max.	JIS C5202 7.9 / IEC60115-1 4.24.2 Cycle ON for 1.5 hrs and OFF for 0.5hrs at 40 $\pm$ 2 $^{\circ}$ C, 90-95% RH with rated voltage for 1000 hrs
Load life	5% $\Delta R(3\% + 0.05 \Omega)$ Max. 1% $\Delta R(1\% + 0.05 \Omega)$ Max.	JIS C5202 7.10 / IEC60115-1 4.25.1 At 70 $^{\circ}$ C rated voltage with The cycle of 1.5hes ON and 0.5hrs OFF for 1000hrs
Resistance to Soldering heat	5% $\Delta R(1\% + 0.05 \Omega)$ Max. 1% $\Delta R(0.5\% + 0.05 \Omega)$ Max. No mechanical damage	JIS C5202 6.4 / IEC60115-1 4.18 260 $\pm$ 5 $^{\circ}$ C for 10 seconds
Intermittent Overload	5% $\Delta R(2\% + 0.05 \Omega)$ Max. 1% $\Delta R(1\% + 0.05 \Omega)$ Max. No mechanical damage	JIS C5202 5.8 4 x rated voltage, 1 sec ON, 25 sec OFF, test 10,000 cycles
Solderability	Well tinned $\geq$ 95% covered No mechanical damage	JIS C5202 6.5 / IEC60115-1 4.17 After immersing flux, dip in 245 $\pm$ 3 $^{\circ}$ C solder bath for 2 $\pm$ 0.5 sec.
Thermal Shock	5% $\Delta R(1\% + 0.05 \Omega)$ Max. 1% $\Delta R(0.5\% + 0.05 \Omega)$ Max.	IEC60115-1 4.19 At -65(+0/-10) $^{\circ}$ C for 2min.and at +155 (+10/-0) $^{\circ}$ C for 2 min., 25 cycles

**CODIGO**

CR0805-XXX

**DESCRIPCION**

Resistor SMD 0805

■ **PACKAGING**

**REEL DIMENSION (mm)**

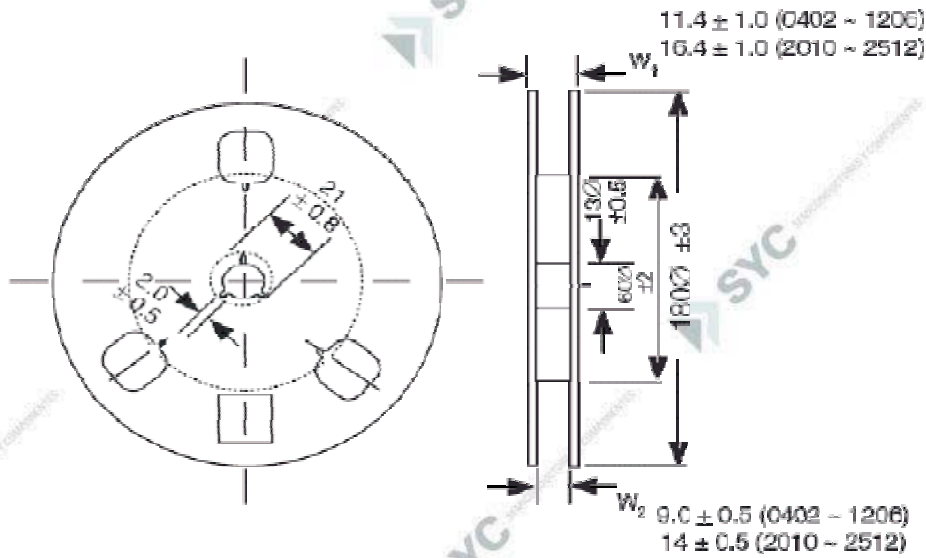

**PAPER TAPE DIMENSIONS (mm)**

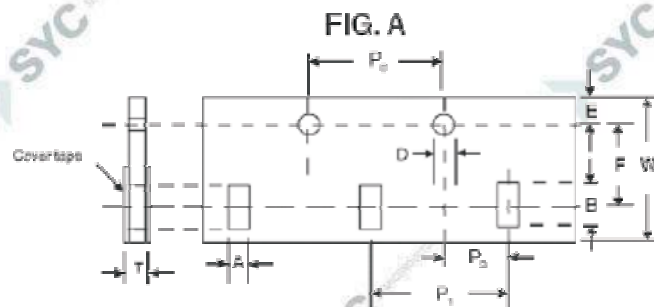

Size	A	B	D	E	F	P <sub>0</sub>	P <sub>1</sub>	P <sub>2</sub>	W	T
0201	0.45±0.1	0.75±0.1	1.5±0.1/-0	1.75±0.1	3.50±0.05	4.0±0.1	2.0±0.05	2±0.05	8±0.1	0.35±0.1
0402	0.65±0.1	1.15±0.1								0.53±0.1
0603	1.10±0.1	1.90±0.1								0.70±0.1
0805	1.65±0.1	2.40±0.1					4.0±0.05			0.85±0.1
1206	1.90±0.1	3.50±0.1								
1210	2.80±0.1	3.50±0.1								

**CODIGO**

CR0805-XXX

**DESCRIPCION**

Resistor SMD 0805

**EMBOSSED TAPE DIMENSIONS (mm)**

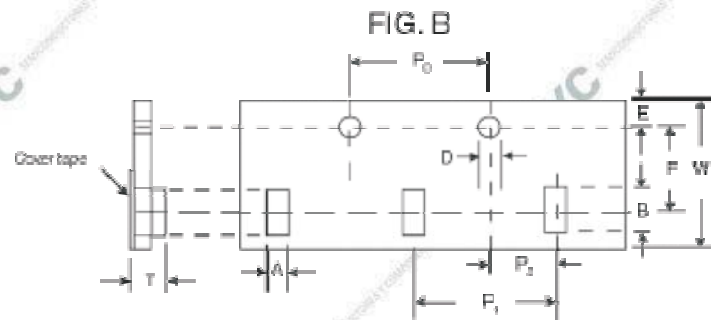

Size	A	B	D	E	F	P <sub>0</sub>	P <sub>1</sub>	P <sub>2</sub>	W	T
2010	2.80±0.2	5.40±0.2	1.5±0.1/-0	1.75±0.1	5.50±0.05	4.0±0.1	4.0±0.1	2±0.05	12.±0.3	1.0±0.1
2512	3.50±0.2	6.7±0.2								

**■ PACKING Q'TY**

Size \ Reel	7 inches Reel	10 inches Reel	13 inches Reel
0201	10,000	20,000	50,000
0402	10,000	20,000	50,000
0603	5,000	10,000	20,000
0805	5,000	10,000	20,000
1206	5,000	10,000	20,000
1210	5,000	-	20,000
*2010	4,000	-	-
*2512	4,000	-	-

\* Embosses Tape