

JFET-Input Operational Amplifiers
Low Supply Current (LF155)
High-Speed (LF156)

FEATURES

- *Guaranteed* Offset Voltage Drift on All Grades
- *Guaranteed* Slew Rate on All Grades
- *Guaranteed* Low Input Offset Current 10pA Max.
- *Guaranteed* Low Input Bias Current 50pA Max.
- *Guaranteed* High Slew Rate (156A/356A) 10V/ μ s Min.
- Fast Settling to 0.01% 1.5 μ s

APPLICATIONS

- Output Amplifiers for D/A Converters
- Fast Sample and Hold Circuits
- High Speed Integrators
- Photocell Amplifiers
- High Input Impedance Buffers

DESCRIPTION

Linear Technology's LF155/156 series features several improvements compared to similar types from other manufacturers: offset voltage drift with temperature and slew rate are guaranteed on all grades, not just on the more expensive "A" grades. Other specifications such as voltage gain and high temperature bias and offset currents are also improved.

The industry standard LF155/156 devices exhibit phase reversal at the output when the negative common-mode limit at the input is exceeded (i.e., from -12V to -15V with $\pm 15V$ supplies). This can cause lock-up in servo systems. As shown below, Linear Technology's LF155/156 does not have this problem due to unique phase reversal protection circuitry. For applications requiring higher performance, see the LT1055 and LT1056 data sheets.

Voltage Follower with Input Exceeding the Negative Common-Mode Range

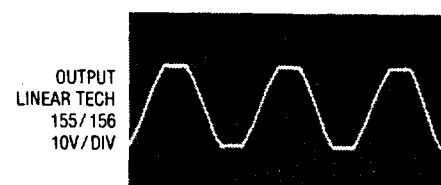
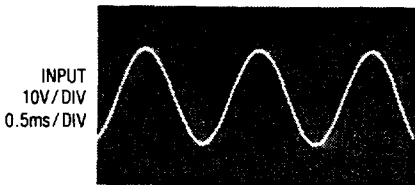
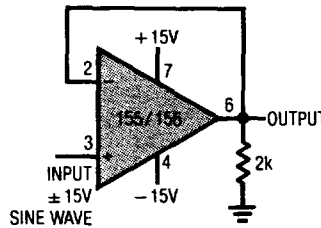

LF155A/355A/155/355 LF156A/356A/156/356

ABSOLUTE MAXIMUM RATINGS

Supply Voltage

LF155A/155/355A, LF156A/156/356A	±22V
LF355/356	±18V

Differential Input Voltage

LF155A/155/156A/156	±40V
LF355A/355/356A/356	±30V

Input Voltage (Note 1)

LF155A/155/156A/156	±20V
LF355A/355/356A/356	±16V

Output Short Circuit Duration

Indefinite

Operating Temperature Range

LF155A/155/156A/156	-55°C to 125°C
LF355A/355/356A/356	0°C to 70°C

Maximum Junction Temperature

LF155A/155/156A/156	150°C
LF355A/355/356A/356	100°C

Storage Temperature Range

All Devices -65°C to 150°C

Lead Temperature (Soldering, 10 sec.) 300°C

PACKAGE/ORDER INFORMATION

TOP VIEW		ORDER PART NUMBER	
<p>H PACKAGE METAL CAN</p>		LF155H	LF156H
		LF155AH	LF156AH
		LF355H	LF356H
		LF355AH	LF356AH
<p>N8 PACKAGE 8 PIN PLASTIC</p>		LF355N8	LF356N8
		LF355AN8	LF356AN8
		V_{OS} is adjusted with a 20k or 50k potentiometer between the balance terminals. The wiper is tied to V^+	

ELECTRICAL CHARACTERISTICS (Note 2)

SYMBOL	PARAMETER	CONDITIONS	LF155A/156A LF355A/356A			LF155/156			LF355/356			UNITS
			MIN	TYP	MAX	MIN	TYP	MAX	MIN	TYP	MAX	
V_{OS}	Input Offset Voltage	$T_A = 25^\circ\text{C}$ Over Temperature 355A/356A	●	1	2	2	3.5	3	8	mV		
			●		2.5		4.8		9	mV		
			●		2.3					mV		
$\frac{\Delta V_{OS}}{\Delta T}$	Average TC of Input Offset Voltage	$R_S = 50\Omega$	●	3	5	5	15	5	25	$\mu\text{V}/^\circ\text{C}$		
	Change in Average TC with V_{OS} Adjust	$R_S = 50\Omega$ (Note 4)	●	0.5		0.5		0.5		$\mu\text{V}/^\circ\text{C}$ per mV		
I_{OS}	Input Offset Current	$T_J = 25^\circ\text{C}$ (Note 3) $T_J \leq 125^\circ\text{C}$ $T_J \leq 70^\circ\text{C}$	●	3	10	3	20	3	50	pA		
			●		9		9		—	nA		
			●		0.7		—		1.5	nA		
I_B	Input Bias Current	$T_J = 25^\circ\text{C}$ (Note 3) $T_J \leq 125^\circ\text{C}$ $T_J \leq 70^\circ\text{C}$	●	30	50	30	100	30	200	pA		
			●		15		15		—	nA		
			●		0.9		—		3.0	nA		
R_{IN}	Input Resistance	$T_J = 25^\circ\text{C}$		10^{12}		10^{12}		10^{12}		Ω		
A_{VOL}	Large Signal Voltage Gain	$V_S = \pm 15\text{V}$, $T_A = 25^\circ\text{C}$, $V_O = \pm 10\text{V}$, $R_L = 2\text{k}$ Over Temperature	●	75	200	50	200	40	200	V/mV		
			●	30		25		25		V/mV		

ELECTRICAL CHARACTERISTICS (Note 2)

SYMBOL	PARAMETER	CONDITIONS	LF155A/156A LF355A/356A			LF155/156			LF355/356			UNITS	
			MIN	TYP	MAX	MIN	TYP	MAX	MIN	TYP	MAX		
V_O	Output Voltage Swing	$V_S = \pm 15V, R_L = 10k$ $V_S = \pm 15V, R_L = 2k$	●	± 12	± 13		± 12	± 13		± 12	± 13	V	
			●	± 10	± 12		± 10	± 12		± 10	± 12	V	
V_{CM}	Input Common-Mode Voltage Range	$V_S = \pm 15V$	●	± 11	$+15.1$ -12		± 11	$+15.1$ -12		± 10	± 15.1 -12	V	
CMRR	Common-Mode Rejection Ratio		●	.85	100		85	100		80	100	dB	
PSRR	Supply Voltage Rejection Ratio	$V_S = \pm 10V$ to $\pm 18V$ $V_S = \pm 10V$ to $\pm 15V$	●	85	100		85	100		—	—	dB	
			●		—			—			80	100	dB
I_S	Supply Current	$T_A = 25^\circ C, V_S = \pm 15V$ LF155/355 Series LF156/356 Series LF356A			2	4		2	4		2	4	mA
					5	7		5	7		5	10	mA
					5	7		—	—		—	—	—
SR	Slew Rate	$A_V = +1$ $T_A = 25^\circ C, V_S = \pm 15V$ LF155/355 Series LF156/356 Series											
				5	7		5	7		2.5	6		V/ μ S
				10	12		9	12		4	12	V/ μ S	
GBW	Gain Bandwidth Product	$T_A = 25^\circ C, V_S = \pm 15V$ LF155/355 Series LF156/356 Series		—	2.5		2.5		2.5		2.5		MHz
				4	5		5		5		5		MHz
t_S	Settling Time to 0.01%	$T_A = 25^\circ C, V_S = \pm 15V$ LF155 Series (Note 5) LF156 Series			4		4		4		4		μ S
					1.5		1.5		1.5		1.5		μ S
e_n	Input Noise Voltage Density	$T_A = 25^\circ C, V_S = \pm 15V$ $f = 100Hz$ LF155 Series LF156 Series			25		25		25		25		nV/ \sqrt{Hz}
					15		15		15		15		nV/ \sqrt{Hz}
					20		20		20		20		nV/ \sqrt{Hz}
				12		12		12		12		nV/ \sqrt{Hz}	
i_n	Input Noise Current Density	$T_A = 25^\circ C, V_S = \pm 15V$ $f = 100Hz$ $f = 1000Hz$			0.01		0.01		0.01		0.01		pA/ \sqrt{Hz}
					0.01		0.01		0.01		0.01		pA/ \sqrt{Hz}
C_{IN}	Input Capacitance		●	3		3		3		3		pF	

The ● denotes the specifications which apply over the full operating temperature range. The shaded electrical specifications indicate those parameters which have been improved or guaranteed test limits provided for the first time.

For MIL-STD components, please refer to LTC 883C data sheet for test listing and parameters.

Note 1: Unless otherwise specified, the absolute maximum negative input voltage is equal to the negative power supply voltage.

Note 2: Unless otherwise stated, these test conditions apply:

	LF155A/156A LF155/156	LF355A/356A	LF355/356
Supply Voltage, V_S	$\pm 15V \leq V_S \leq \pm 20V$	$\pm 15V \leq V_S \leq \pm 18V$	$V_S = \pm 15V$
T_A	$-55^\circ C \leq T_A \leq +125^\circ C$	$0^\circ C \leq T_A \leq +70^\circ C$	$0^\circ C \leq T_A \leq +70^\circ C$

and V_{OS} , I_B and I_{OS} are measured at $V_{CM} = 0$.

Note 3: The input bias currents are junction leakage currents which approximately double for every $10^\circ C$ increase in the junction temperature, T_j . Due to limited production test time, the input bias currents measured are correlated to junction temperature. In normal operation the junction temperature rises above the ambient temperature as a result of internal power dissipation, P_D . $T_j = T_A + \Theta_{JA} P_D$ where Θ_{JA} is the thermal resistance from junction to ambient. Use of a heat sink is recommended if input bias current is to be kept to a minimum.

Note 4: The temperature coefficient of the adjusted input offset voltage changes only a small amount ($0.5\mu V/^\circ C$ typically) for each mV of adjustment from its original unadjusted value. Common-mode rejection and open loop voltage gain are also unaffected by offset adjustment.

Note 5: Settling time is defined here for a unity gain inverter connection using $2k\Omega$ resistors. It is the time required for the error voltage (the voltage at the inverting input pin on the amplifier) to settle to within 0.01% of its final value from the time a 10V step input is applied to the inverter.

LF155A/355A/155/355 LF156A/356A/156/356

TYPICAL PERFORMANCE CHARACTERISTICS

Gain, Phase vs Frequency

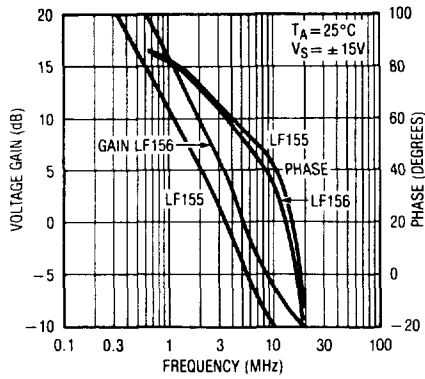

Inverter Settling Time

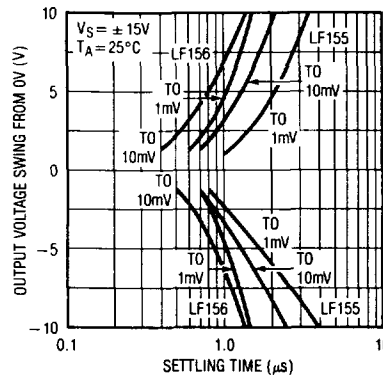

Normalized Slew Rate vs Temperature

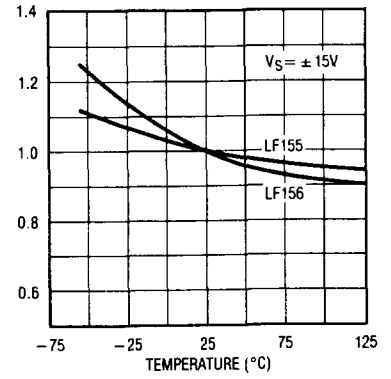

Supply Current vs Temperature

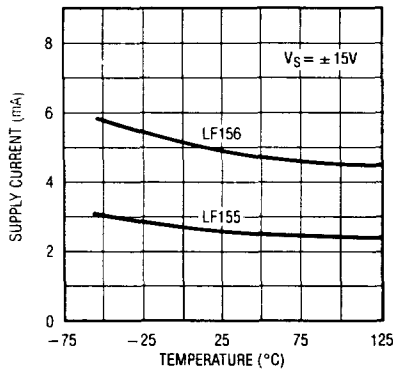

LF156 Large Signal Response

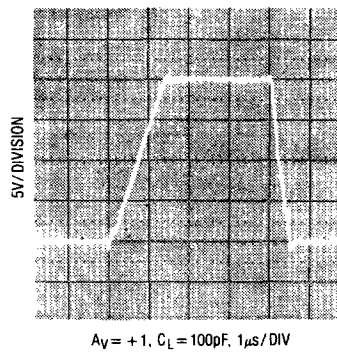

LF156 Small Signal Response

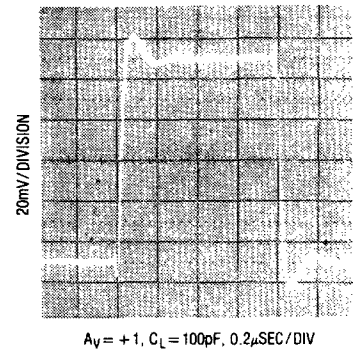

PACKAGE DESCRIPTION Dimensions in inches (millimeters) unless otherwise noted.

H Package Metal Can

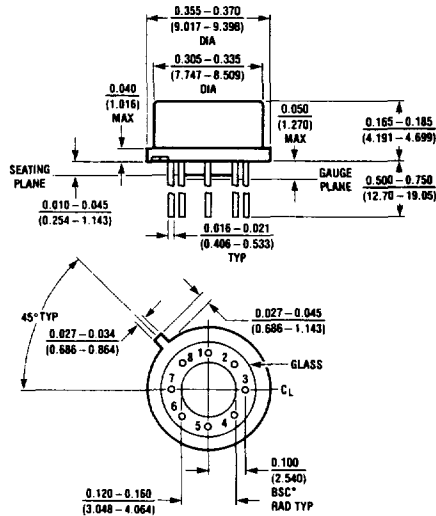

T_{jmax}	θ_{ja}	θ_{jc}
150°C	150°C/W	45°C/W

N8 Package 8 Lead Plastic

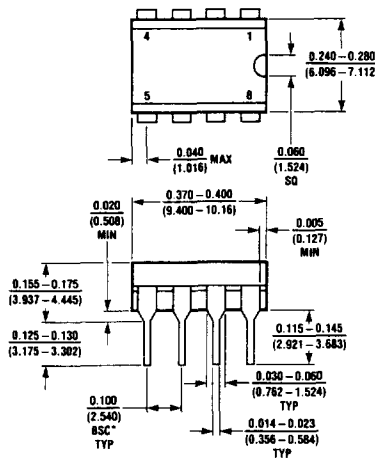

*LEADS WITHIN 0.007 OF TRUE POSITION (TP) AT GAUGE PLANE

T_{jmax}	θ_{ja}
100°C	130°C/W