

# BC327/328

BC327/328

## Switching and Amplifier Applications

- Suitable for AF-Driver stages and low power output stages
- Complement to BC337/BC338

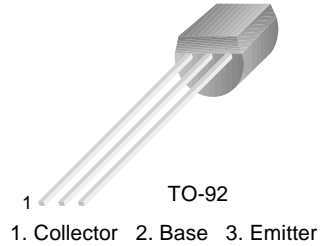

## PNP Epitaxial Silicon Transistor

### Absolute Maximum Ratings $T_a=25^\circ\text{C}$ unless otherwise noted

Symbol	Parameter	Value	Units
$V_{CES}$	Collector-Emitter Voltage		
	: BC327	-50	V
	: BC328	-30	V
$V_{CEO}$	Collector-Emitter Voltage		
	: BC327	-45	V
	: BC328	-25	V
$V_{EBO}$	Emitter-Base Voltage	-5	V
$I_C$	Collector Current (DC)	-800	mA
$P_C$	Collector Power Dissipation	625	mW
$T_J$	Junction Temperature	150	$^\circ\text{C}$
$T_{STG}$	Storage Temperature	-55 ~ 150	$^\circ\text{C}$

### Electrical Characteristics $T_a=25^\circ\text{C}$ unless otherwise noted

Symbol	Parameter	Test Condition	Min.	Typ.	Max.	Units
$BV_{CEO}$	Collector-Emitter Breakdown Voltage	$I_C = -10\text{mA}, I_B = 0$				
	: BC327		-45			V
	: BC328		-25			V
$BV_{CES}$	Collector-Emitter Breakdown Voltage	$I_C = -0.1\text{mA}, V_{BE} = 0$				
	: BC327		-50			V
	: BC328		-30			V
$BV_{EBO}$	Emitter-Base Breakdown Voltage	$I_E = -10\mu\text{A}, I_C = 0$	-5			V
$I_{CES}$	Collector Cut-off Current					
	: BC327	$V_{CE} = -45\text{V}, V_{BE} = 0$		-2	-100	nA
	: BC328	$V_{CE} = -25\text{V}, V_{BE} = 0$		-2	-100	nA
$h_{FE1}$ $h_{FE2}$	DC Current Gain					
		$V_{CE} = -1\text{V}, I_C = -100\text{mA}$	100		630	
		$V_{CE} = -1\text{V}, I_C = -300\text{mA}$	40			
$V_{CE}(\text{sat})$	Collector-Emitter Saturation Voltage	$I_C = -500\text{mA}, I_B = -50\text{mA}$			-0.7	V
$V_{BE}(\text{on})$	Base-Emitter On Voltage	$V_{CE} = -1\text{V}, I_C = -300\text{mA}$			-1.2	V
$f_T$	Current Gain Bandwidth Product	$V_{CE} = -5\text{V}, I_C = -10\text{mA}, f = 20\text{MHz}$		100		MHz
$C_{ob}$	Output Capacitance	$V_{CB} = -10\text{V}, I_E = 0, f = 1\text{MHz}$		12		pF

### $h_{FE}$ Classification

Classification	16	25	40
$h_{FE1}$	100 ~ 250	160 ~ 400	250 ~ 630
$h_{FE2}$	60-	100-	170-

# Typical Characteristics

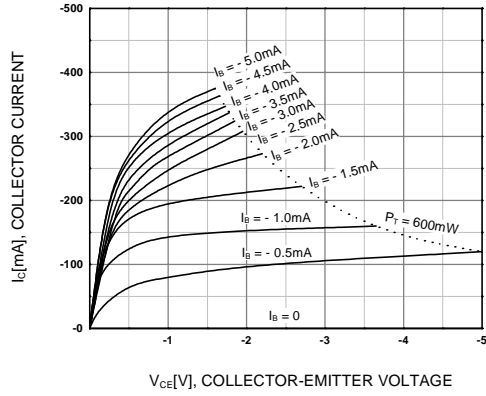

Figure 1. Static Characteristic

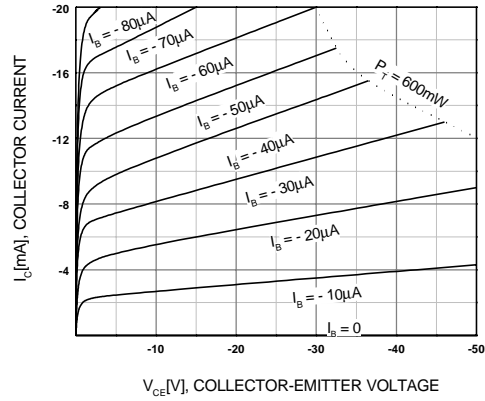

Figure 2. Static Characteristic

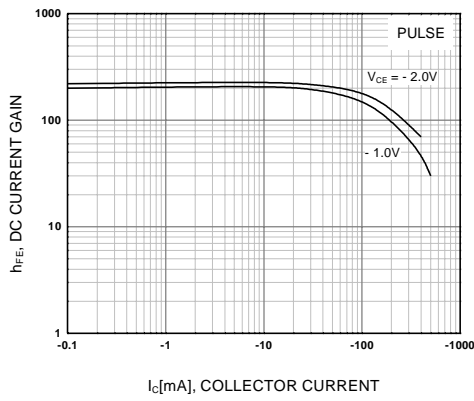

Figure 3. DC current Gain

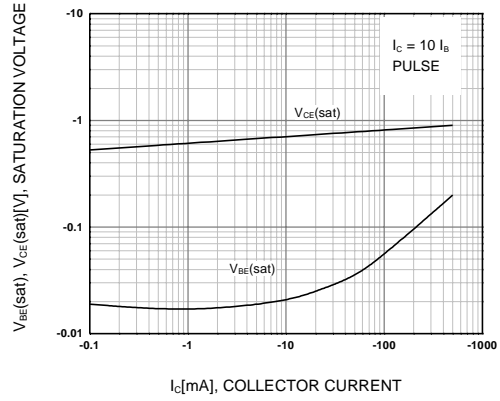

Figure 4. Base-Emitter Saturation Voltage  
Collector-Emitter Saturation Voltage

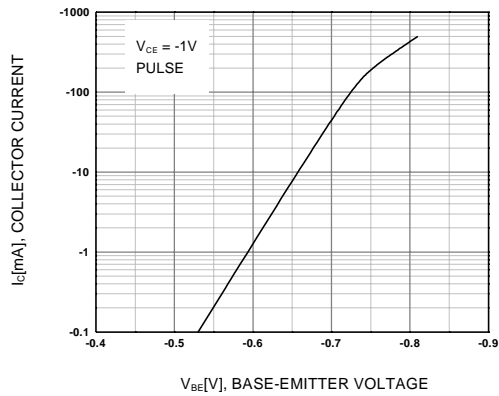

Figure 5. Base-Emitter On Voltage

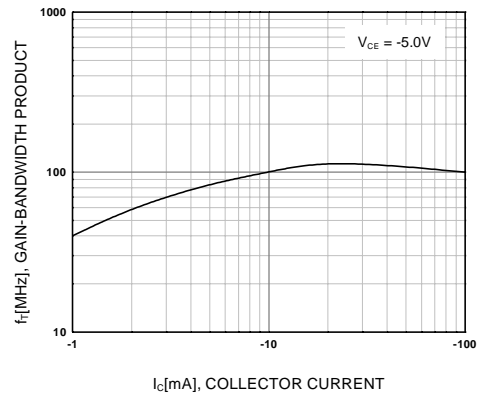
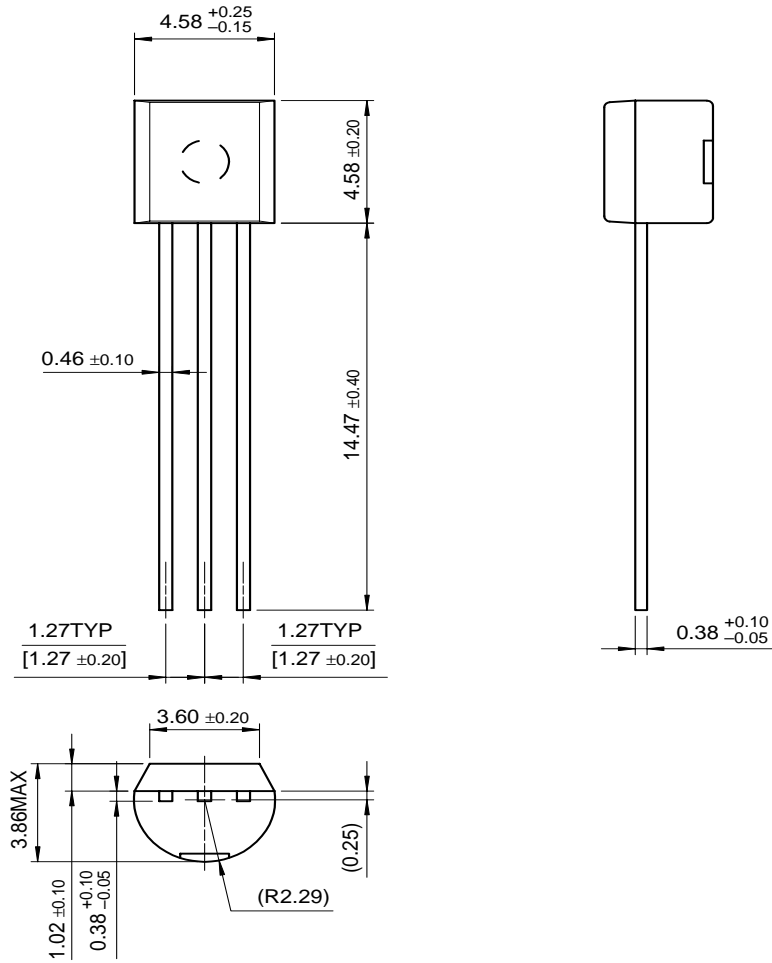

Figure 6. Gain Bandwidth Product

# Package Dimensions

BC327/328

## TO-92



Dimensions in Millimeters