

LED-010-65064



ATTENTION
OBSERVE PRECAUTIONS
FOR HANDLING
ELECTROSTATIC
DISCHARGE
SENSITIVE
DEVICES

Features:

- Single color
- High Radiant Flux
- Low power consumption
- High reliability and long life

Descriptions:

- Dice material: INGaN
- Emitting Color: Ultraviolet
- Device Outline: ϕ 5mm Round Type
- Lens Type: Water Clear

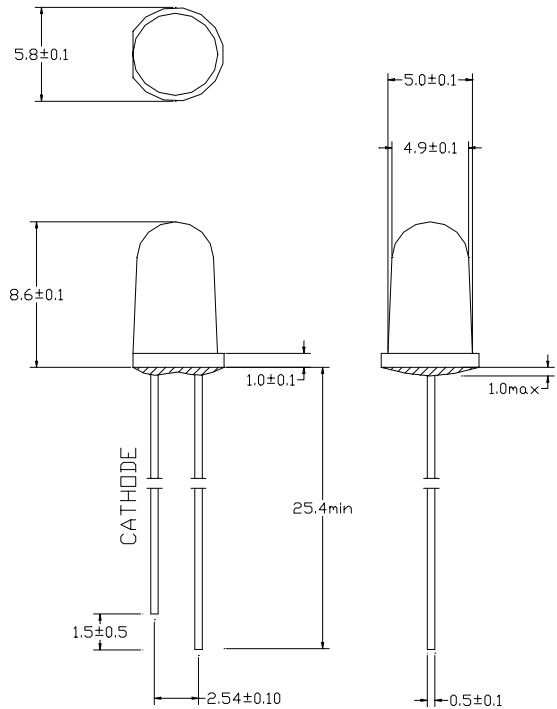

Note:

- All dimensions are millimeters.
- Tolerance is $\pm 0.25 \text{ mm}$ unless otherwise noted

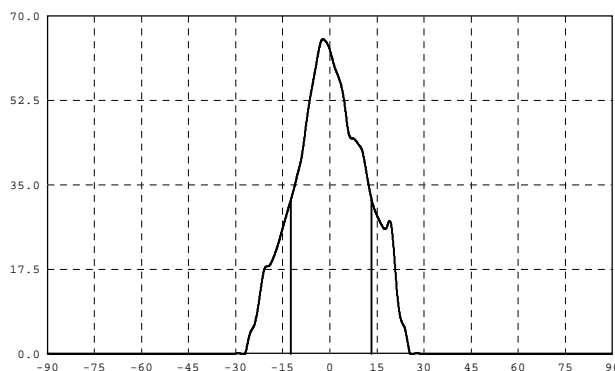

LED SPECIFICATION

Absolute maximum ratings (Ta = 25°C)

Parameter	Symbol	Test Condition	Value		Unit
			Min.	Max.	
Reverse Voltage	V _R	I _R = 30 μ A	5	--	V
Forward Current	I _F	----		30	mA
Power Dissipation	P _d	----	----	105	mW
Pulse Current	I _{peak}	Duty=0.1mS, 1kHz	----	100	mA
Operating Temperature	T _{opr}	----	-20	+85	°C
Storage Temperature	T _{str}	----	-25	+100	°C

Electrical and optical characteristics (Ta = 25°C)

Parameter	Symbol	Test Condition	Value			Unit
			Min.	Typ.	Max.	
Forward Voltage	V _F	I _F = 20mA	3.0	3.7	4.0	V
Reverse Current	I _R	V _R = 5V	----	----	30	μ A
Dominate Wavelength	λ _d	I _F = 20mA	400	---	405	nm
Spectral Line half-width	Δ λ	I _F = 20mA	----	25	----	nm
Radiant Flux	I _V	I _F = 20mA	----	12	----	mW
Viewing Angle	2 θ 1/2	I _F = 20mA	28		35	Deg.

LED SPECIFICATION

Typical electrical/optical characteristic curves:

